

STH1440
STH1840

SANY

Quality Changes the World



EFFICIENCY ON HIGHEST LEVEL

HIGHER. STRONGER. BETTER.



TELEHANDLERS
STH1440 | STH1840

Load capacity
4,000 kg
Maximum lifting height
14 m / 18 m
Rated power
55 KW

SANY

STH1440 | STH1840

**Performance comes from quality.
Quality comes from experience.**

SANY Europe is part of the SANY Group, a globally leading manufacturer of construction machinery, port equipment and wind turbines. Our aim is always to deliver products that are tailored to their respective national market and equipped with high-performance, innovative technology. SANY ensures maximum quality and reliability through the use of its own steel construction and branded components, allowing us to create extraordinarily efficient machines. What is more, our Europe-wide dealer network ensures that users can receive competent support for sales, service and maintenance on site.

> 100
DEALER
IN EUROPE

5-7%
FROM REVENUE AS AN INVESTMENT
FOR RESEARCH AND DEVELOPMENT

UP TO **5 YEARS'**
WARRANTY*

Quality Changes the World

* Only from participating dealers



POWERHOUSES THAT PROVIDE A MIGHTY BOOST

SANY is bringing a breath of fresh air to Europe with its new telehandler series. The completely overhauled machines have once again substantially raised the benchmark for safety, convenience and performance. The STH1440 and STH1840 telehandlers are the first machines to feature in the new series. Whether they are deployed as construction plant, industrial applications or transshipment equipment, they go above and beyond in any

application for which other lifting devices would simply suffice. Thanks to their compact and robust design, they serve as the perfect powerhouses for loading and stacking. And that's not all: A diverse range of attachments can also be added to individually expand the functionality of the machines.



VERSATILITY AT THE HIGHEST LEVEL

The new SANY telehandlers are powerful all-rounders that stand out on account of their agility and speed. Thanks to their compact design and a selection of three different steering modes, they can be perfectly positioned in even the tightest of spaces and bring heavy loads up to a lifting height of up to 18 metres. With their various attachment options, they quickly prove themselves as indispensable all-rounders that can handle a wide variety of tasks.

LIFTING CAPACITY

Lift, extend and push – the highly efficient and powerful hydraulics allow operators to work with precision under short cycle times.

SAFETY

Stability counts – the stability of our telehandlers is automatically regulated through monitoring of the machine movements and of the load weight. Consequently, hazardous situations are avoided in combination with limitation of the use of the chassis levelling or use of the stabilisers when the specified heights are exceeded.

EFFICIENCY

Precision to the power of three – with three selectable steering modes, the SANY telehandlers offer the ideal solution for any manoeuvre, allowing desired positions to be quickly reached with ease. The steering types include two-wheel steering, four-wheel steering and crab steering.

TOTAL COST OF OWNERSHIP

Every second counts – SANY telehandlers are designed to maximise return on your investment and to compete in today's crowded construction market. For example, the engine Stop-Start technology not only reduces fuel consumption, also reduces time to the next service which we have set intervals at 500 hrs to minimise operating costs.

QUALITY

Stability as standard – the boom is mounted deep in the chassis, providing an extremely rigid structure, a low centre of gravity and maximum view from the cab over the rear of the machine.

OPERATING COMFORT

Breathe freely – the high-performing air conditioning system as standard ensures a constant supply of fresh air and can be selected from fresh to recirculation via the touch screen. This ensures that the operator can maintain their focus even in hot working environments.

PRODUCTIVITY

The easy way to save – the powerful 55 kW engine from Deutz requires no exhaust treatment. In other words, there's no need for any heat-resistant lubricating oils or Diesel Exhaust Fluid (AdBlue) additives. This maximizes material handling with regard to diesel consumption and maintenance effort.



Absolute reliability – for peace of mind!

SANY's warranty of up to 5 years* gives you the assurance that you can fully count on your equipment.

* Only from participating dealers



Our highlights – the added benefits SANY offers you:

- + Compact, high-performance telehandler
- + Highly manoeuvrable with three different steering modes
- + Robust and extremely durable thanks to solid steel construction
- + Extensive safety equipment
- + Integrated reversing camera and pulse radar as standard



SAFETY

A COMPREHENSIVE SAFETY PACKAGE AS STANDARD

Numerous safety features are already included ex-works in all SANY telehandlers. For example, they have an especially precise weight system built in, which is accurate to within 5% and is connected to the load management system. This monitors the weight of the machine and prevents instability. The specific capacity is displayed to the operator on the dashboard and on the LMI strip light at eye level. Further safety features include a reversing camera with impulse radar, which is automatically activated when the reverse gear is engaged.

The operator also receives visual and acoustic warnings if they come within close proximity of other objects. Also included are a ROPs and FOPs certified cabin frame as standard give maximum protection of the operator, a safety switch that prevents any vehicle movement when the operator is not seated, as well as hose burst safety check valves fitted on all lift cylinders stopping collapse in the event of a failure or damage. Optional screen, roof and load guards are also available.



SAFETY

In the spotlight

The standard LED working lights at the front and rear of the cab optimise field of vision and visibility in poor light conditions, e.g. when working at night or in halls with dark areas. The LED roof liner lighting with three selectable settings provides light directly above and behind the operator as required. Optional boom worklights guarantee optimal illumination above the machine when loading to height improving visibility and safety.

SAFETY

The ultimate view

All SANY telehandlers offer maximum visibility of the operator's surroundings for added safety. This is achieved through features such as the low engine bonnet line and the deep position of the boom. The generously sized side and rear mirrors guarantee all-round visibility for safer operation. The low position of the dashboard combined with the windshield and large glazed roof provide an excellent view of what's in front and above, with a maximised panoramic view to prevent risks and hazards from being obscured.



QUALITY

High efficiency through high quality

SANY telehandlers are designed to provide the maximum in terms of reliability and operating hours. We achieve this by using high-quality components and innovative manufacturing procedures. For example, the boom sections consist of two C-shaped high-strength pressed steel parts that are welded together, making them particularly stable and extremely durable. The highly loaded stabilisers are fitted with robust graphite-impregnated bronze bushings, which extends the maintenance intervals to 500 hours. And all the hoses of the boom are safely routed internally to ensure that they are maximally protected against damage.



QUALITY

Tested on the basis of day-to-day work

The machines have undergone a stringent SANY testing programme that includes heavily loading the chassis, the boom and other important components for an extended duration, as well as repeated use of the transmission over thousands of cycles.

Our finite element analysis and numerous testing procedures guarantee the structural stability and longevity of the machine, even under extreme operating conditions. For example, tests to simulate the service life and durability of the components have been conducted on a boom test rig with more than 40,000 cycles and no breakages.

USER EXPERIENCE

AMPLE SPACE FOR AMPLE COMFORT

The cab has been designed in Germany and is a highlight for any driver. It provides maximum comfort for pleasant working through numerous standard features. These include, for example, the 7-inch touchscreen display with encoder control, with intuitive user navigation which allows quick access to all relevant vehicle data. The document pocket on the dashboard and the armrest with integrated USB connector for your telephone, a cup holder and Bluetooth connection are equally practical. Also included as standard – the inclinable and telescopic steering column, which allows any driver to make comfortable adjustments to find the perfect operating position.



PRODUCTIVITY

SETTING THE BENCHMARK

The new SANY telehandler series stands out on account of the machines' excellent manoeuvrability and short travel times. Even when space is limited, destinations can still be reached quickly and safely. This is possible thanks to a choice of three different steering modes: two-wheel steering, which is intended for everyday use; four-wheel steering, for working within space constraints; and crab steering, for positioning or manoeuvring the machine in the immediate vicinity of a wall or building. Another factor for outstanding productivity – the powerful load-sensing system, which controls the hydraulic pressure in proportion to the different outputs. This means the boom can be lifted and extended simultaneously.



EFFICIENCY

SAVE WHILE YOU DRIVE

In times of constantly rising fuel costs, an energy-efficient drive system is more important than ever. For this reason, the SANY telehandlers are fitted with a powerful common rail injection system and electronic engine control (EMR) with intelligent connection to the drive management system. This provides optimum engine power at a low level of fuel consumption. The Dana transmission and the axles are also perfectly coordinated to ensure maximum performance and efficiency. Furthermore, the Deutz 55 kW engine operates without exhaust treatment and therefore requires no

AdBlue additives. Using the main display, the operator is able to access information on the remaining fuel, the amount of fuel consumed since the machine was last refuelled, and the current average rate of fuel consumption.

EASE OF MAINTENANCE

Maintenance made quick and easy

All daily checks and maintenance work can be performed from the ground. The filters for engine oil, hydraulic oil and fuel are fitted centrally and the air filter is also easily accessible from the engine compartment. The engine cover can be easily opened with the gas-powered cylinder and allows the engine to be accessed comfortably from three sides. Making work even easier – the battery can be easily reached at any time via an upwards-folding step under the cab.

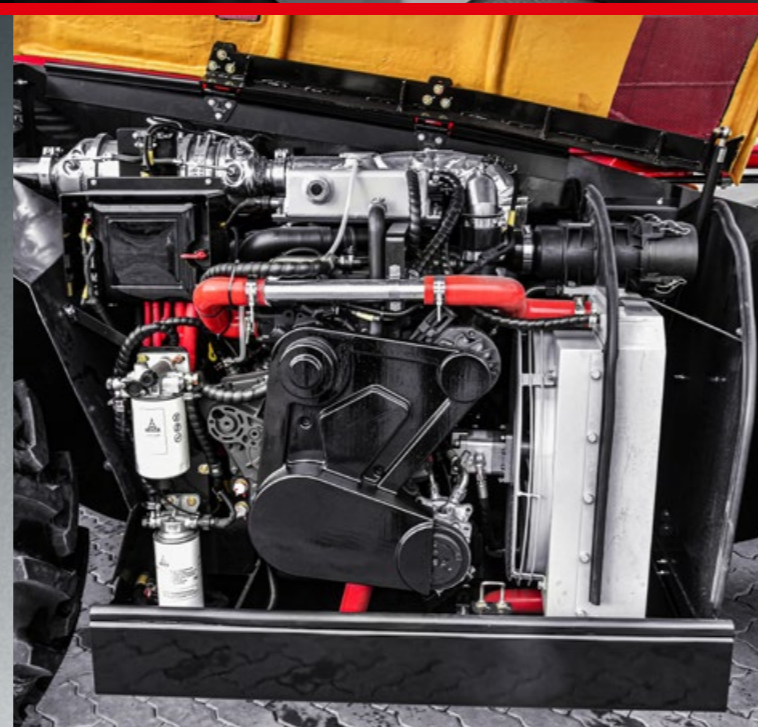

ENGINE

Model	Cummins QSF3.8
No. of cylinders	4
Exhaust emissions	Teir 3
Rated power	55 kW / 2,600 rpm

COMPONENTS

Axles F/R	Dana 212/Dana 212
Hydraulic pump	CASAPPA gear pump
Hydraulic manifold	Walvoil

TRANSMISSION

Transmission type	Dana hydrostatic shift-on-fly
Number of gears	2 forward 2 reverse
Max. travel speed	27 km/h

BRAKING

Parking brake	Automatic parking brake
Service brake	Oil-immersed multi-discs braking on front & rear axle

HYDRAULIC SYSTEM

Hydraulic pump type	Gear with priority valve
System pressure	260 bar
Hydraulic flow	110 l/min

SERVICE REFILL CAPACITIES

Fuel tank	150 l
Hydraulic system	120 l

TYRES

Type/size	400/80R-24
-----------	------------

OPERATING MASS

	STH1440	STH1840
	10,980 kg	12,300 kg

PERFORMANCE PARAMETERS

	STH1440	STH1840
Maximum lift capacity	4,000 kg	4,000 kg
Lift capacity at maximum height	3,000 kg	2,500 kg
Lift capacity at maximum reach	1,250 kg	550 kg
Lift height	13,970 mm	17,550 mm
Carriage crowd angle	37°	37°
Carriage dump angle	12,5°	12,5°
Frame levelling +/-	9°	9°
Outside turning radius (4WS)	3,850 mm	3,850 mm
Auxiliary hydraulic flow	60 l/min	60 l/min
Auxiliary hydraulic pressure	28 MPa	28 MPa
Noise at driving position (55 kW)	75 Lpa	75 Lpa
Noise to environment (55 kW)	83 Lwa	83 Lwa

BOOM PARAMETERS

	STH1440	STH1840
Boom (raise/lower)	18/13 sec	15/12 sec
Boom (extend/retract)	15/13 sec	16/19 sec

POINT LOADS

Machine loaded with models maximum capacity

	STH1440	STH1840
Load per front tyre	6,608 kg	7,200 kg
Load per rear tyre	883 kg	950 kg
Load per stabiliser	4,913 kg	5,225 kg

Machine unloaded with boom horizontal travel position

	STH1440	STH1840
Load per front tyre	2,677 kg	2,970 kg
Load per rear tyre	2,841 kg	3,180 kg

STH1440 – OUTRIGGERS DOWN

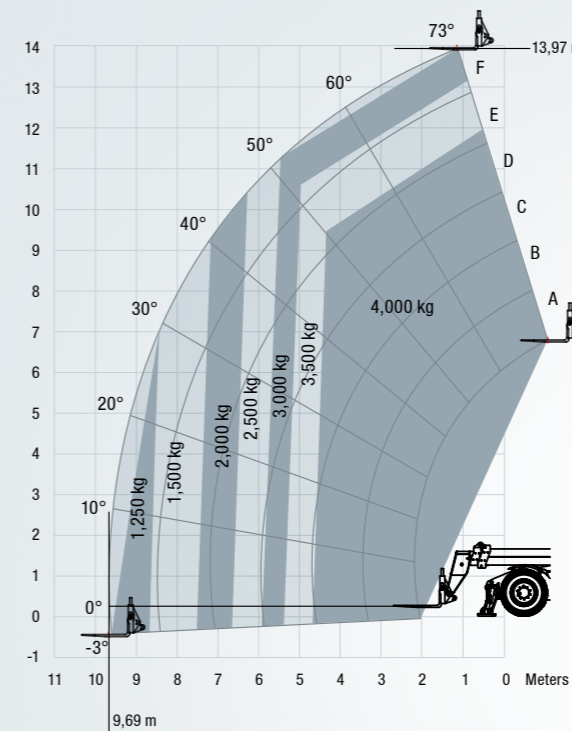

STH1440 – OUTRIGGERS UP

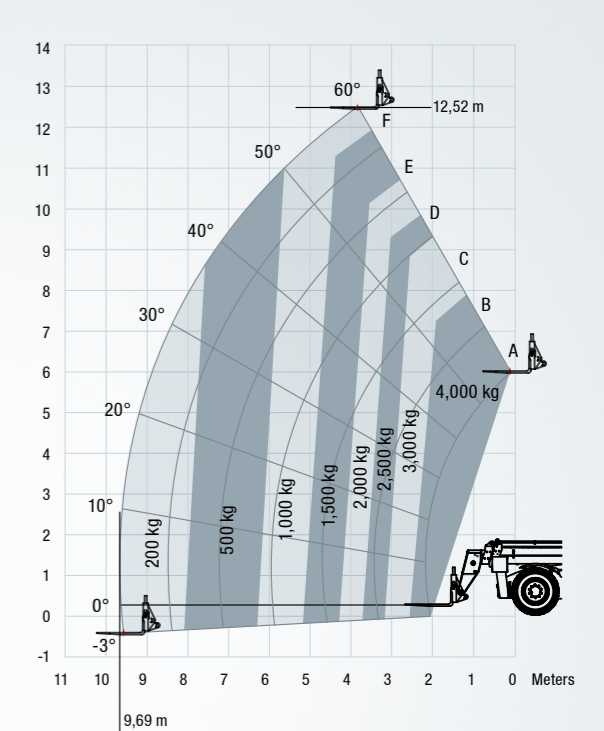

STH1840 – OUTRIGGERS DOWN

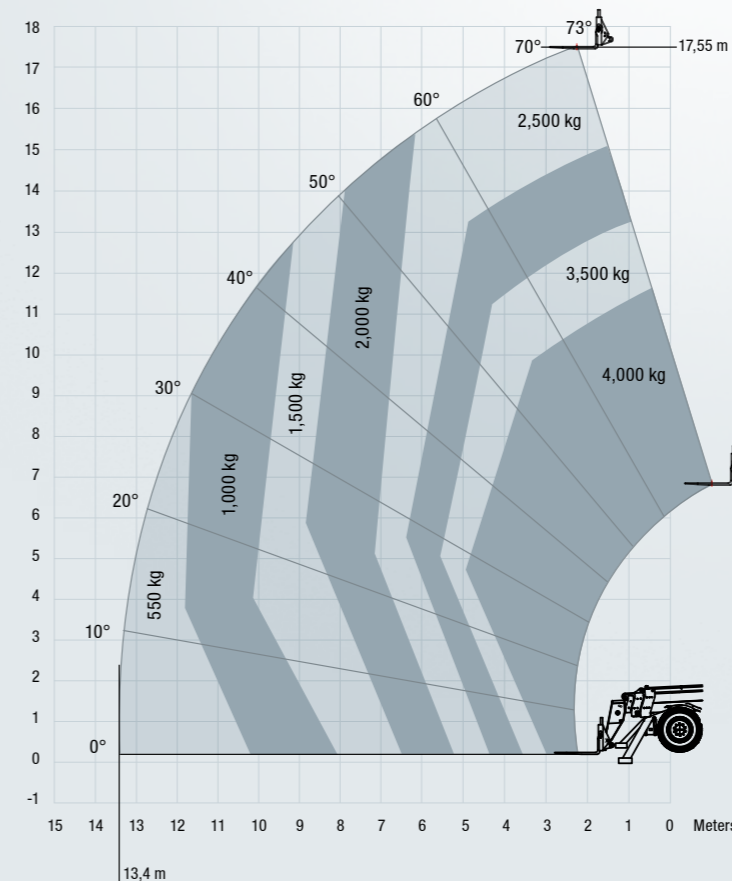

STH1840 – OUTRIGGERS UP

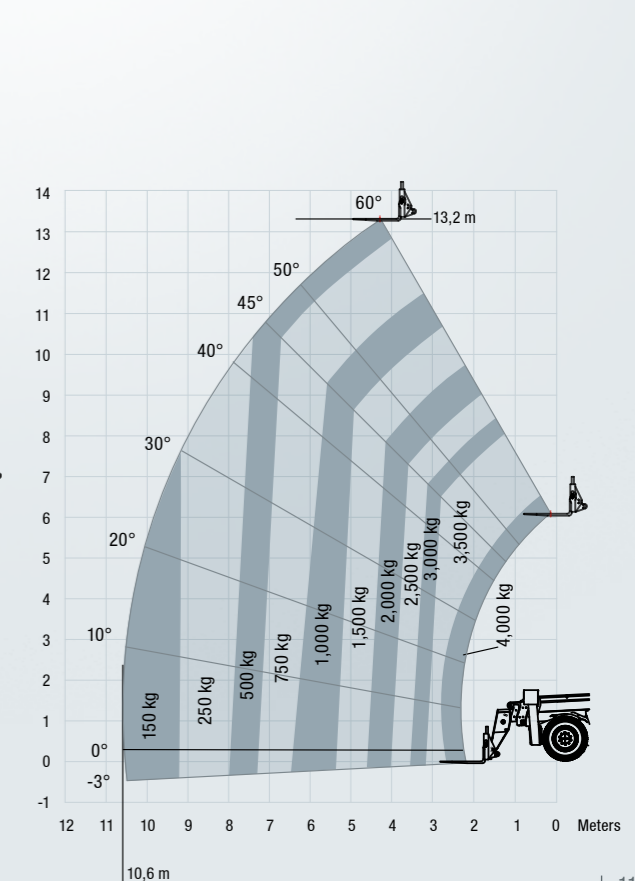

DIMENSIONS

	STH1440	STH1840
A Length to front of carriage	6,160 mm	6,200 mm
B Overall width	2,420 mm	2,420 mm
D Height over cab without beacon	2,595 mm	2,595 mm
E Height over cab with beacon	2,720 mm	2,720 mm
F Wheelbase	2,750 mm	2,750 mm
G Overall cabin width	950 mm	950 mm
H Ground clearance	370 mm	370 mm
Overall width stabilisers fully deployed	2,570 mm	3,400 mm
Turning radius over tyres	3,850 mm	3,850 mm
Operating mass (with Forks)	10,980 kg	12,300 kg

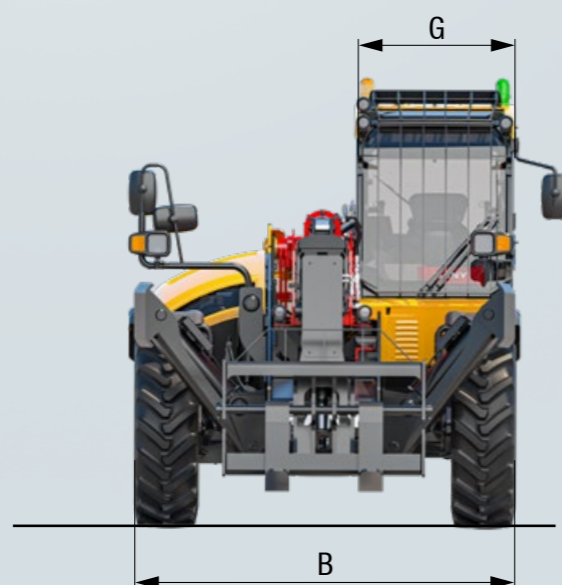
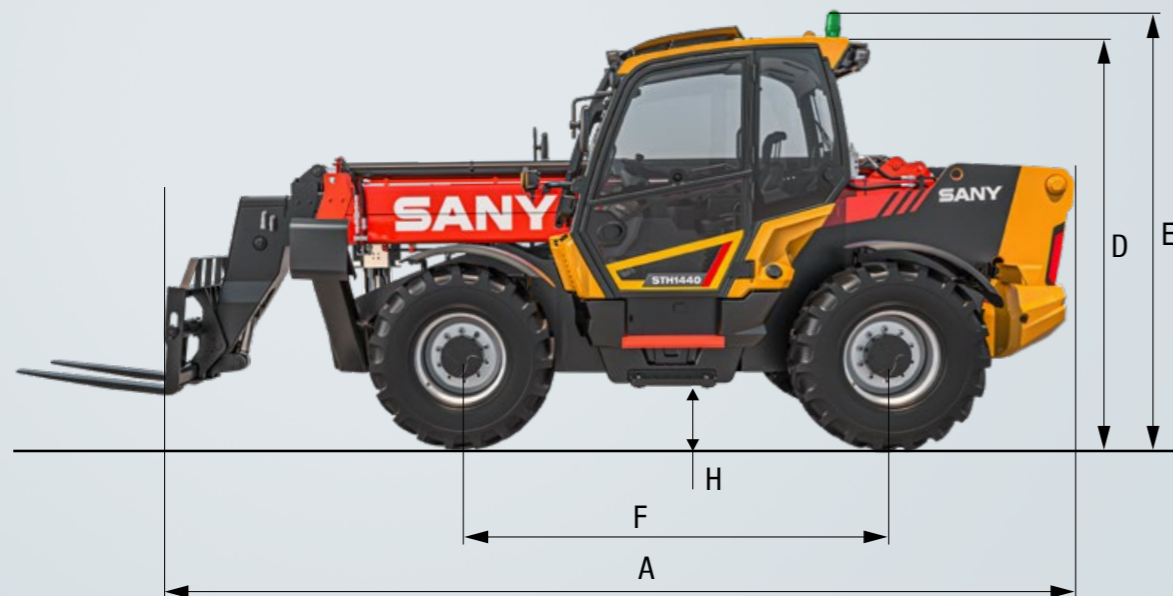

More features, more possibilities

All SANY telehandlers are comprehensively equipped ex works, meaning that they quickly prove themselves as powerful all-rounders. With numerous options and attachments, they can be individually configured as necessary – leaving them perfectly equipped for the respective requirements.



● STH1440 ● STH1840

The standard and special options differ according to the country in which the machine is delivered. If you have any questions, please contact your dealer directly.

OPERATING COMFORT/CAB

Seven-inch touchscreen display and encoder navigation	●	●
Air conditioning*	●	●
Radio with Bluetooth and microphone	●	●
Adjustable seat with suspension	●	●
USB/AUX connections	●	●
12 V power socket	●	●
Sunblind, roof and front screen	●	●
Heated rear screen	●	●
Front, roof and rear wiper and washers	●	●
Armrest with storage and USB charger	●	●
Cup and bottle holders	●	●
Fully adjustable steering column	●	●
Intuitive keypad functions (all backlit)	●	●
Telematics	●	●

WORK EQUIPMENT

Three steering modes: 4WS, 2WS and crab	●	●
Chassis levelling +/-9 degrees	●	●
Fully proportional joystick with FNR	●	●
Fixed SANY fast fit carriage and 1200 mm forks	●	●
Auxiliary hydraulic venting from cab	●	●

* The air-conditioning system contains fluorinated greenhouse gases: Refrigerant type: HFC 134a, global warming potential: 1430, quantity: 65 kg, CO2e: 0.933 tonnes.

WORKING LIGHTS

LED working lights on cab and boom	●	●
Full road lights	●	●

SAFETY

CE-/UKCA-certified	●	●
ROPS ISO:3471:2008 and FOPS ISO:3449:2005	●	●
Automatic park brake system	●	●
Reversing alarm	●	●
Hi-viz seatbelt	●	●
Integrated reversing camera and pulse radar	●	●
Seat switch and green "ready" beacon	●	●
Load weight monitoring	●	●
Load moment Indicator display	●	●

Parts supply – fast and reliable

By purchasing a SANY telehandler, you have invested in the future. Fast availability of spare parts is your guarantee of minimal downtimes and failure times.



TAILORED ATTACHMENTS FOR VERSATILE APPLICATIONS

In addition to the comprehensive ex works configuration, the application possibilities of the SANY telehandlers can be individually expanded further. To this end, SANY offers a range of suitable attachments. It's worth noting that these attachments can also be added and removed quite easily thanks to the hydraulic additional bleed valve. The operator can easily control this via the keyboard in the cab.

CARRIAGE

LIGHTWEIGHT DIRECT MOUNTED FORK FRAME

Designed for the rental industry with forks fully secured.



MANITOU TYPE CARRIAGE AND FORK FRAME

Allows flexibility to use existing attachments for maximum utilisation of equipment.



SANY FAST FIT CARRIAGE

Compatible with a large selection of attachments, the common pick up configuration allows use with existing attachments.



ATTACHMENTS

GENERAL PURPOSE BUCKET

For transporting loose material and bulk material with a bucket capacity of 1 m³.

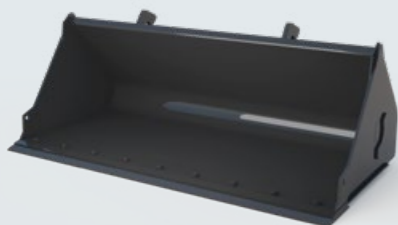

HYDRAULIC FORK POSITIONERS

Control your forks widths from your fingertips, saving time when changing loads and eliminates leaving the cabin improving operator fatigue and importantly safety.



4,000 KG CRANE HOOK

Can be easily fitted to SANY's Fast Fit Carriage for suspended loads when handling slung material.



A SERVICE YOU CAN RELY ON

Maintenance and servicing are essential for the efficiency, cost-effectiveness and safety of every machine. You can count on the support of your SANY dealer, our expertise in heavy-duty vehicles, SANY's high quality standards and quick spare parts

availability. This gives you the certainty that your telehandler will always be quickly ready for use again, even after unplanned downtime.

SANY – flexible, fast and always there for you

Rapid assistance, tailored advice and a reliable supply of original parts – that is what we mean by a premium service.



The added benefits SANY offers you:

- + Fast supply thanks to the central warehouse near Cologne
- + More than 15,000 spare parts to make your machine highly reliable
- + Expert knowledge for optimal supply for your machine
- + Thanks to SANY's special training programme, our dealers are always kept up-to-date so that they can face all technical challenges.



Detailed information in black and white

Handbooks and documents are available for all SANY telehandlers, and these can help you with operation, maintenance, servicing and repairs. These include operating and maintenance instructions and technical specifications.



HIGHLIGHTS **STH1440** | **STH1840**

QUALITY REALLY DOES CHANGE THE WORLD

SANY's telehandler range is designed to meet the exact needs of the construction and rental industry. Coming will be a wide range of different styles and sizes, SANY's versatile telehandler offers you all the safety, durability, versatility and low cost of ownership that you need to compete in today's construction market.



SAFE AND SECURE

SANY telehandlers incorporate many safety features to keep the operator and co-workers safe, reversing camera and pulse radar fitted as standard, seat sensor ensures operators are seated before drive is engaged, all fitted with a precise weighing system so capacity can be monitored.

COST OF OWNERSHIP

SANY telehandler aren't just efficient to use – it's hugely efficient to own and operate too. We've designed these machines to give you the maximum possible return on your investment, with great fuel efficiency and low running costs all part of the package.

DURABLE COMPONENTS

Designed and tested to high quality, our tough boom is mounted deep in the fully welded chassis. All our booms are tested with a boom rig that operates the boom to full lift height and full extension loaded to endure 40,000 cycles.

A PRODUCTIVE MACHINE

For ergonomic, fast and precise control all SANY telehandlers are fitted with full proportional joystick. Coupled with our load sensing hydraulic system, which proportionally splits flow to different services, means the boom can be lifted and extended simultaneously.

COMFORT AND EASE OF USE

Our cabin has been designed in Germany for the European market, knowing that when your cabins your office comfort is key. Designed for maximum all-round visibility and comfort with controls well placed and storage a plenty.

SERVICABILITY

Firstly you want your SANY telehandler to spend as much time as possible at work, not being worked on. SANY recognises this and our telehandlers have long service intervals; and when maintenance is required, you'll find our machines are easy and quick to service.

TECHNICAL HIGHLIGHTS

Engine	Deutz TD 3.6L
Rated power	55 kW
Max. torque	340 Nm/1,600 rpm
Maximum lift capacity	4,000 kg
Frame levelling	+/-9 degrees
Auxiliary hydraulic flow	60 l/min
Auxiliary hydraulic pressure	28 MPa

Not all products are available in all markets. As part of our continuous improvement process, we reserve the right to modify specifications and designs without giving prior notice. The figures may contain additional options.

SANY

Quality Changes the World

SANY EUROPE GmbH
Sany Allee 1
D-50181 Bedburg, Germany
Tel. +49 2272 90531 100
Fax +49 2272 90531 109
info@sanyeurope.com
www.sanyeurope.com